

**Global engineering -
Trusted solutions**



OWNER'S MANUAL

Pressure Blast Cabinet

BNP series

(BNP 65, 75, 85, 220, 601 & 721)

Clemco
International GmbH

Carl-Zeiss-Straße 21
83052 Bruckmühl
Germany







Tel.: +49 (0) 8062 – 90080
Mail: info@clemco.de
Web: www.clemco-international.com

INDEX

1	ABBREVIATIONS, DEFINITIONS, SYMBOLS AND ICONS.....	4
2	GENERAL INFORMATION	4
2.1	Technical documents	4
2.2	Other applicable documents.....	4
3	SCOPE OF MANUAL	5
4	PRODUCT DESCRIPTION	5
4.1	Conventional utilization and restrictions	5
4.2	No conventional utilisation – Warnings for misuse.....	5
4.3	Operating mode of the complete system	6
4.4	Description	7
4.4.1	Media-recovery system (Cyclone)	7
4.4.2	Blast machine.....	7
4.4.3	Dust collector cartridge	8
4.4.4	Control elements	8
4.5	Energy consumption	8
4.6	Emissions	8
5	SET-UP FOR INITIAL INSTALLATION.....	9
5.1	Carriage / Handling	9
5.1.1	BNP 65 and BNP 220	9
5.1.2	BNP 75 und BNP 85	9
5.1.3	BNP 601 and BNP 721	10
5.1.4	Cyclone	10
5.2	Unpackung and disposing the packing material	10
5.3	Requirements.....	10
5.3.1	Required space for BNP 65 and 220	11
5.3.2	Required space: BNP 75 and BNP 85.....	11
5.3.3	Required space for BNP 601	12
5.3.4	Required space for BNP 721	12
5.4	Set-up, assembling and operation checkout.....	13
6	INSTRUCTION HANDBOOK.....	14
6.1	Set up and operation, Shut down	14
6.2	Emergency stop	14
6.3	Shut down by longer interruption of work or moving the cabinet.....	14
6.4	Special procedures	15
6.4.1	Depressurizing	15

6.4.2	Adjust media / air mixture	15
6.4.3	Negative pressure, view, media consumption and flow	15
6.4.4	Media unloading	16
6.4.5	Pulsing (cleaning) dust collector cartridge / replace cartridge / disposal of residues	16
6.4.6	Window replacement	17
6.4.7	Adjust door safety interlock	17
7	MAINTENANCE AND CLEANSE	17
7.1	Preface	17
7.2	If required	18
7.3	After max. 8 h of blasting	18
7.4	After max. 50 h of blasting	18
7.5	After max. 150 h of blasting	18
7.6	After other periodes of time	18
8	TROUBLESHOOTING	19
9	ADMITTED MODIFICATIONS FOR USERS	21
10	REPLACEMENT PARTS	21
10.1	Replacement parts BNP 65, BNP 75, BNP 85 and BNP 220	21
10.2	Replacement parts BNP 601 and 721	23
10.3	Pneumatic circuit- manual abrasive metering valve	25
10.4	Blast machine	28
10.5	Nozzles, Blast hose, Couplings, etc	28
10.6	Foot pedal	28
10.7	Cyclon pression	29
10.8	Dust collector and blower	31
10.9	Control box	31
10.10	Options - different voltage and power	31
10.11	Grounding	32
10.12	Options, Accessories	32
10.12.1	Further options	33
11	DISPOSAL	33

1 Abbreviations, definitions, symbols and icons

	<p>Risk of injury! Connect electric circuit points only by authorized electrician</p>		<p>Electrostatic strokes! Ground!</p>
	<p>Noise > 85 dB(A)! Wear ear protection</p>		<p>Explosion hazard caused by dust! Ground!</p>
	<p>Explosion hazard! Connect only max. admitted pressure.</p>		<p>Risk of injury! Discharge completely pressure during maintenance jobs.</p>

2 General information

2.1 Technical documents

The technical documents are part of the machine and contains important manufacturer information. The technical documentation is intended for everyone who uses the cabinet.

These operating instructions provide important information on handling the device. The precondition for safe working is compliance with all specified safety instructions and handling instructions. In addition, the local accident prevention regulations applicable to the area in which the device is used and the general safety regulations must be followed. Read the operating instructions carefully before starting any work! It is part of the product and must be kept in the immediate vicinity of the device and be accessible to staff at all times. These technical documents must be made available to all persons who use the blasting cabinet under their own responsibility. Those responsible for the plant and operation must ensure that the documentation has been read and understood completely. On the basis of this documentation and taking into account the industrial safety regulation, appropriate maintenance and test plans as well as operating instructions for the operating and maintenance personnel must be derived.

	<p>NOTE! The illustrations in these instructions are for basic understanding and may differ from the actual design of the device.</p>
---	--

2.2 Other applicable documents

The following operating instructions must also be noted:

- Operating instructions single-chamber pressure blasting devices with manual metering valve, pilot pressure regulator, TLR outlet valve and water separator

- Operating instructions pressure cyclone

- Operating instructions for the MBX Filter

3 Scope of manual

These operating instructions apply to the following cabinet types. Please also note the operating instructions for the components used.

Part no.:	Designation of the cabinet	Components		
		Blast machine (pot)	Pressure cyclone	Filter
12611Z	BNP 65 DS	SC 2040	900 CFM (25,4 m ³ /min)	MBX 1500
12613Z	BNP 220 DS	SC 2040	900 CFM (25,4 m ³ /min)	MBX 1500
100401	BNP 601 DS	SC 2040	900 CFM (25,4 m ³ /min)	MBX 1500
100412	BNP 721 DS	SC 2040	900 CFM (25,4 m ³ /min)	MBX 1500
100749	BNP 721 DS	SC 2040	900 CFM (25,4 m ³ /min)	MBX 2000
Option	BNP 75 / BNP 85			

4 Product description

4.1 Conventional utilization and restrictions

	BNP 65 / 75	BNP 220 / 85	BNP 601	BNP 721
Max. loading rate of the grate /floor	1000 N 100 kp	1000 N 100 kp	2500 N 250 kp	2500 N 250 kp
Max. loading rate of the housing	2000 N 200 kp	2000 N 200 kp	10 000 N 1000 kp	10 000 N 1000 kp
Max. load rating with rack (standard)	2000 N 200 kp	2000 N 200 kp	2500 N 250 kp	2500 N 250 kp
Operating time	Continuous duty			
Basic parameters	See attached yellow cover			

4.2 No conventional utilisation – Warnings for misuse

Utilization is interdicted:

As a blow –off cabinet in use of explosive and /or harmful solvents

- in explosion hazard zones
- for blasting parts, where hazardous materials were released
 - o by explosion hazards
 - o which where not retained enough by the dust collector
 - o which causes damages caused to somebodys health during a defectuous dust collector

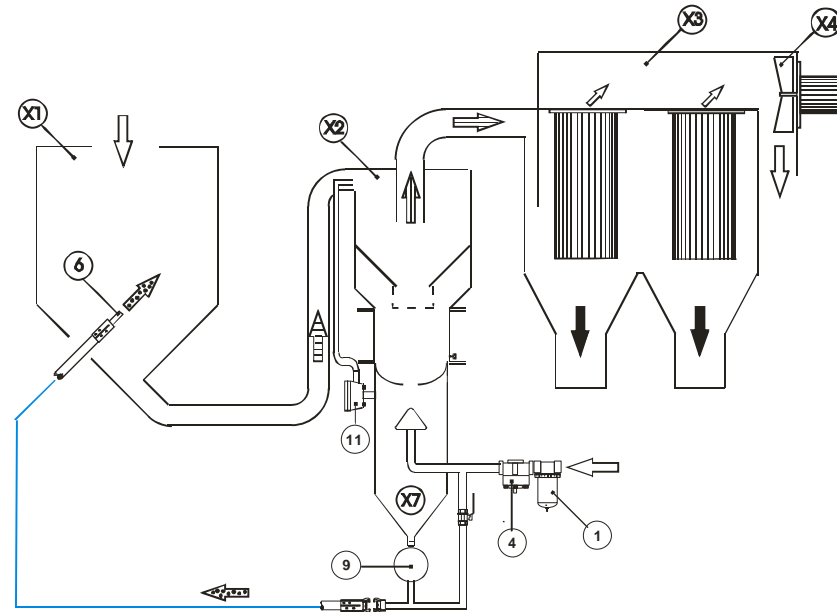

4.3 Operating mode of the complete system

Abrasive circuit flow - Basic principle

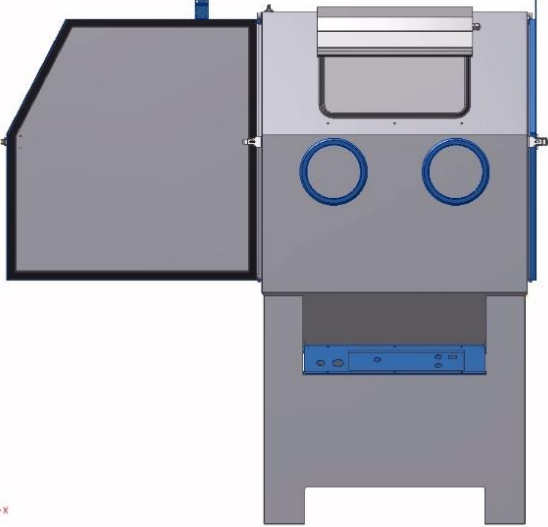

	Pure air	9 / -QN1	Manual abrasive metering valve
	Abrasive, dust and air	-- / -QM2 + -QM 5	Diaphragm valve /cleaning
	Abrasive and air	11 / -QM4	Outlet valve
	Dust and air	-- / -RM1	Check valve
	Dust	-- / -BG1 + BG2	Pneumatic dustbin monitoring
1 / -HS1	Moisture separator, dust collector	-- / -BP2	PE-converter of dustbin monitoring
2 / -QM3	Ball valve	-- / --QM8 + -QM9	Ball valve
3 / -KH1 + -KH2	Pilot regulator	-- / -RN3	Cleaning nozzle cabin
4 / -KH3	Pressure regulator auch Einlaßventil	X1	Blast cabinet
-- / -PG1 + -PG3	Manometer	X2	Reclaimer
6 / -RN1	Blast Nozzle	X3	Cartridge dust collector
-- / -QM1	3/2-way solenoid valve	X4	Exhaust muffler
-- / -RN2 + -RN4	Cleaning nozzle Filter	X5	E-box
SJ 1	Pneum. Fußpedal	X7	Blast machine

4.4 Description

BNP 65 or BNP 220	BNP601 or 721
	
BNP 75 and BNP 85	
	

4.4.1 Media-recovery system (Cyclone)

- Cyclone principle
- Deposition of:
 - o Dust in dust collector
 - o Good media in circuit
 - o Coarse impurities in screen

4.4.2 Blast machine

- o Volume: 100l
- o Media metering valve: manual
- o Controlled by foot pedal

4.4.3 Dust collector cartridge

- Standard: cartridge dust collector MBX
- Automatically cleaning with jet pulse and after running process
- Recommendations for MBX-Filter
 - Pulse interval: ca. 40..60 s
 - Pulse duration: ca. 500 ms
 - Follow up cleaning: ca. 5min
- exchangeable cartridge.
- Dust container

4.4.4 Control elements

	where	notes /functiones
Pressure regulation blasting	Control box	2 to 7 bar
Dedusting filter cartridge	Pressure regulator on air balance vessel – Backside of blast cabinet	Preference pressure: 5 bar
ON/OFF	Control box	Activating: <ul style="list-style-type: none">- Control circuit-Fan-Light-Filter cartridge dedusting function (After running process)
Emergency STOP	Control box	Deactivating electrical supply

4.5 Energy consumption

- Air consumption: see yellow cover
- Electrical connection: see machine shield

4.6 Emissions

See yellow cover.

5 Set-up for initial installation

5.1 Carriage / Handling

5.1.1 BNP 65 and BNP 220

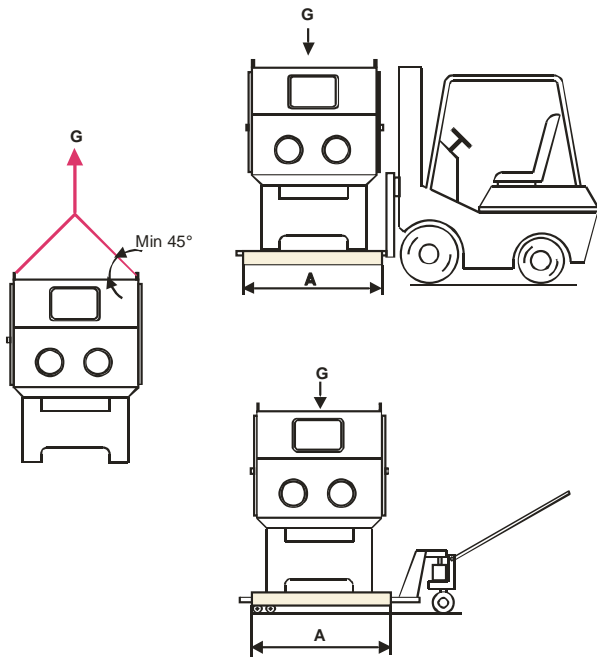

BNP	Weight		A (mm)
65	2500 N	250 kg	1100
220	2800 N	280 kg	1450

5.1.2 BNP 75 und BNP 85

	<table border="1"> <thead> <tr> <th>BNP</th> <th colspan="2">Weight</th> <th>A (mm)</th> <th>B (mm)</th> </tr> </thead> <tbody> <tr> <td>75</td> <td>5000N</td> <td>500 kg</td> <td>2200</td> <td>1200</td> </tr> <tr> <td>85</td> <td>5600 N</td> <td>560 kg</td> <td>2900</td> <td>1300</td> </tr> </tbody> </table>	BNP	Weight		A (mm)	B (mm)	75	5000N	500 kg	2200	1200	85	5600 N	560 kg	2900	1300
BNP	Weight		A (mm)	B (mm)												
75	5000N	500 kg	2200	1200												
85	5600 N	560 kg	2900	1300												

5.1.3 BNP 601 and BNP 721

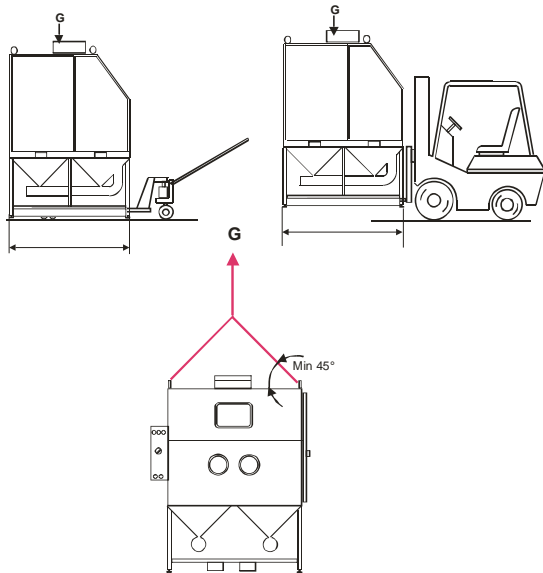

BNP	Gewicht		A (mm)
601	8000 N	800 kg	1500
721	10 000 N	1000 kg	1850

5.1.4 Cyclone

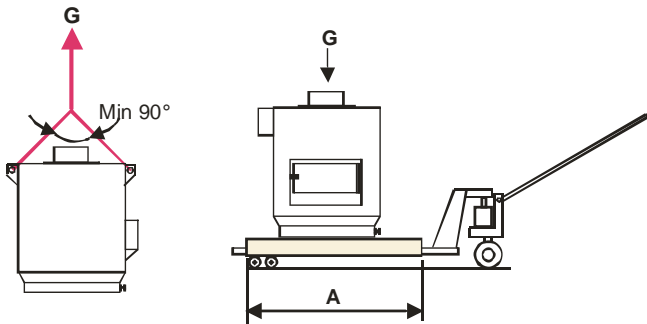

Type	weight		A (mm)
900	500 N	50 kg	800 mm*)
1200	700 N	70 kg	800 mm*)

5.2 Unpacking and disposing the packing material

- Pallet: Wooden pallets 800 x1200
- Plastic film

5.3 Requirements

- Basic requirements: see yellow cover sheet

5.3.1 Required space for BNP 65 and 220

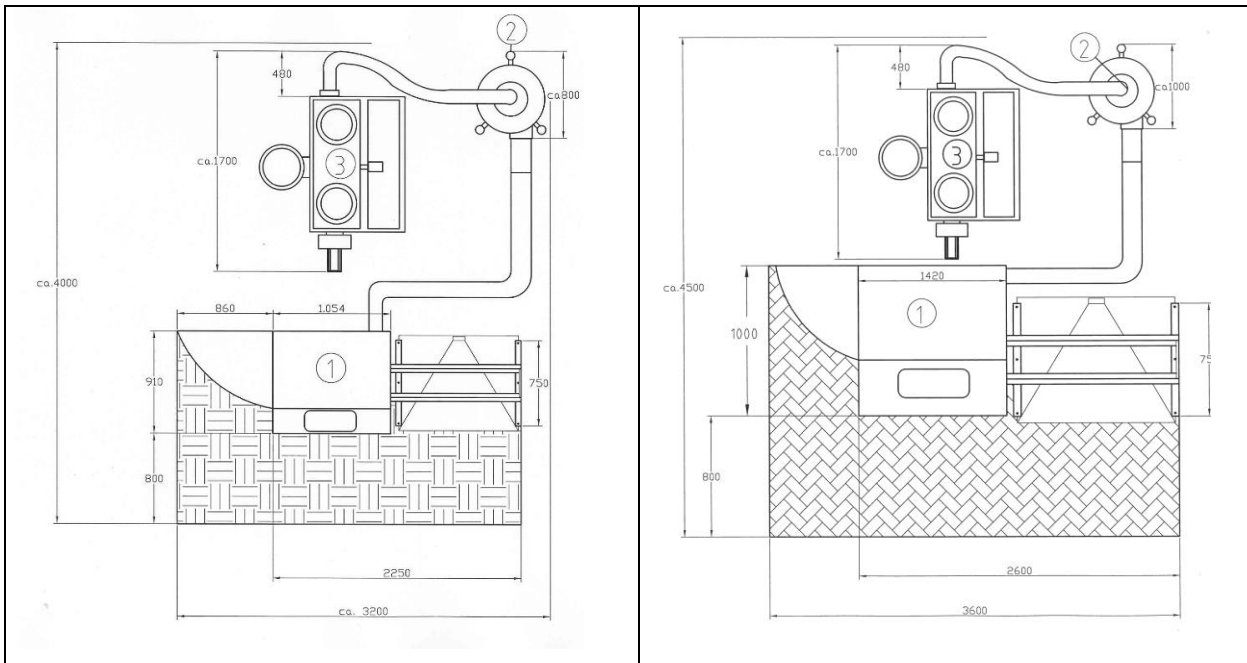

Picture 3: Required space for BNP-65 & 220 with stand alone cyclone and MBX-filter

Pos 1	BNP 65(left) und BNP 220 (right)
Pos 2	Cyclon (900 oder 1200 CFM) + blast pot
Pos 3	MBX Filter 1500 CFM

5.3.2 Required space: BNP 75 and BNP 85

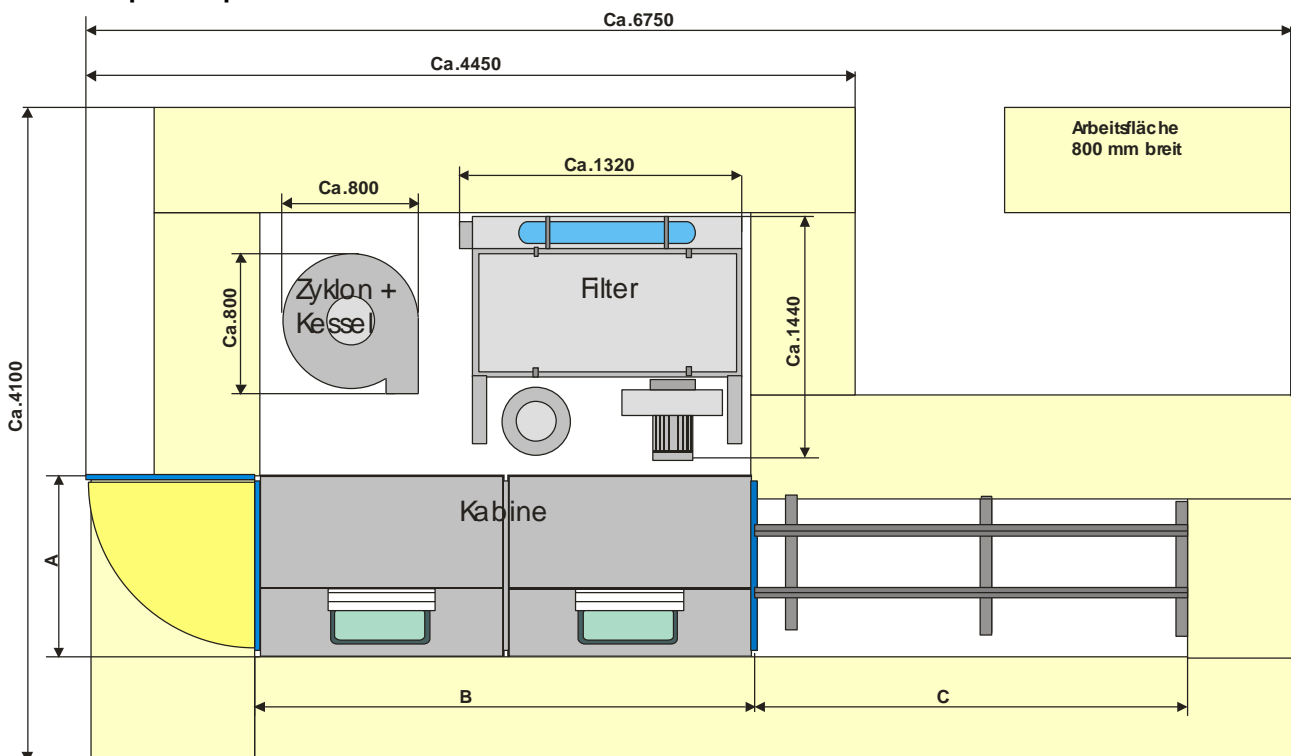

	BNP 75	BNP 85
A (mm)	910	1000
B (mm)	2120	2850

5.3.3 Required space for BNP 601

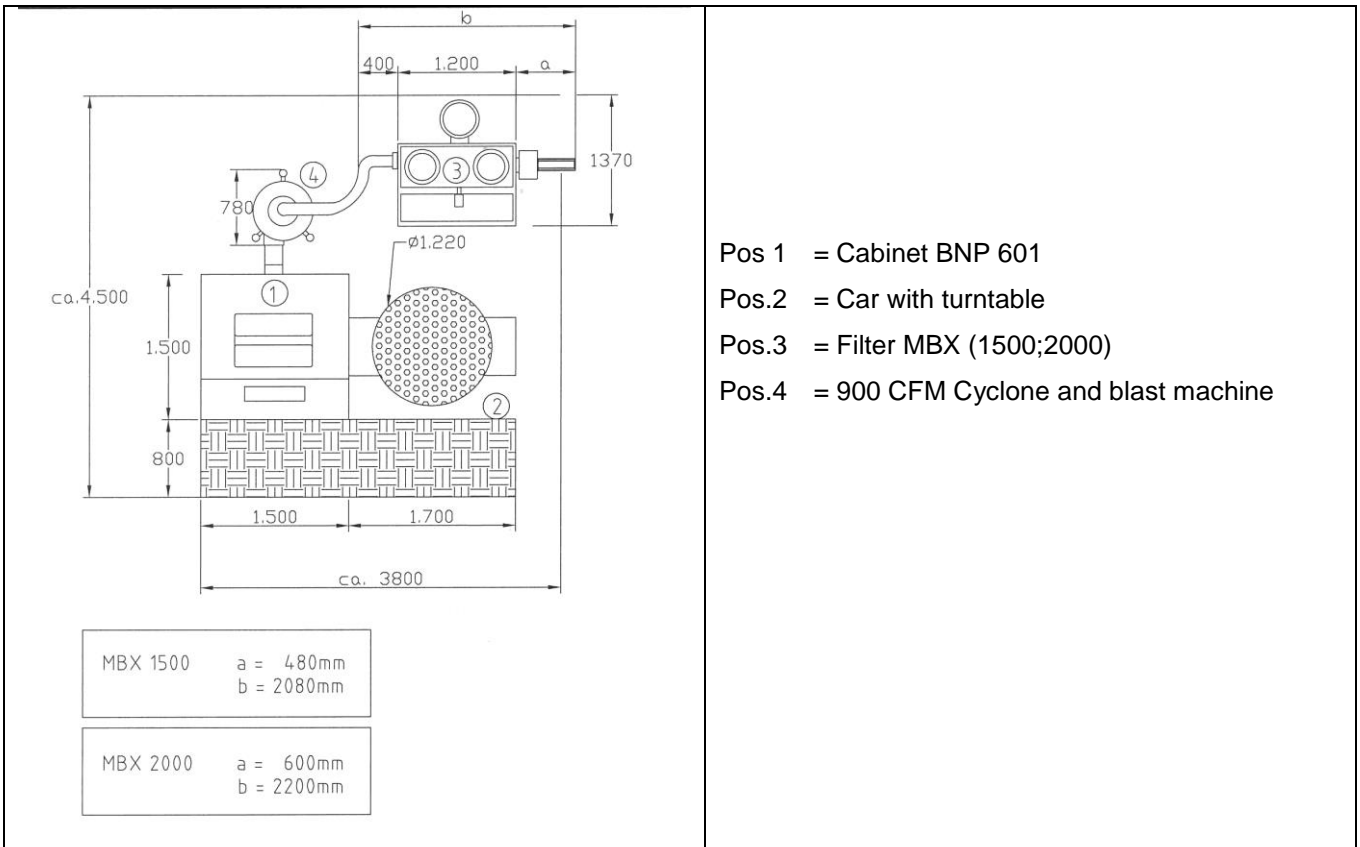

- Pos.1 = Cabinet BNP 601
- Pos.2 = Car with turntable
- Pos.3 = Filter MBX (1500;2000)
- Pos.4 = 900 CFM Cyclone and blast machine

Picture 4a: Required space for BNP-601



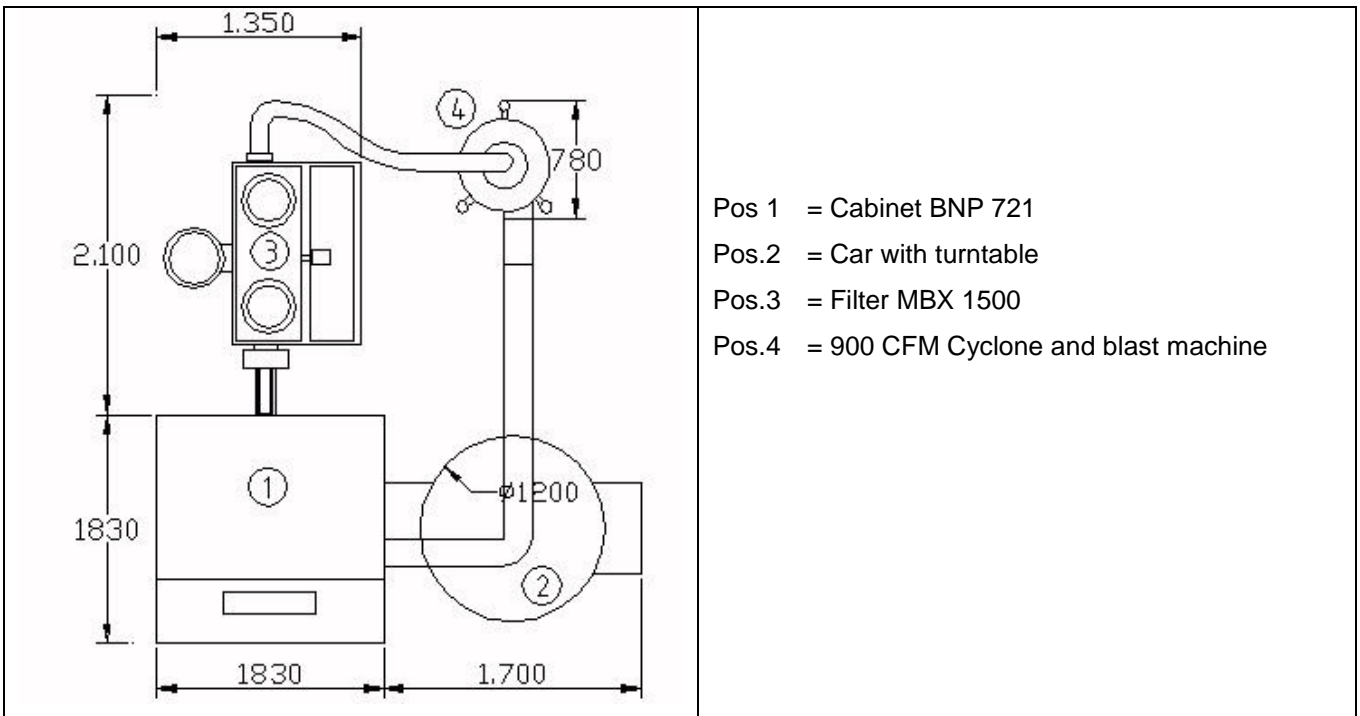







5.3.4 Required space for BNP 721



- Pos.1 = Cabinet BNP 721
- Pos.2 = Car with turntable
- Pos.3 = Filter MBX 1500
- Pos.4 = 900 CFM Cyclone and blast machine

Picture 4b: Required space for BNP-721

5.4 Set-up, assembling and operation checkout

<p>Cabinet set-up.</p>	<p>-Requirements: see yellow cover -Bracing in the floor: for blast pot and cyclon – other parts not necessary</p>	
	 Warning	<p>Warning! Explosion hazard! Connect only max. admitted pressure</p>
<p>Air supply</p>	<p>- max. 7 bar - for higher pressures install pressure regulator and safety valve between cabinet and air supply -Air hose between air supply and cabinet: + Inner diameter : min 19 mm + Lenght: max. 10m</p>	
<p>Filter cartridge dedusting</p>	<p>Adjust pressure regulator for dedusting to 5 bar</p>	
	 Warning	<p>Warning! Risk of injuri! Connect electric circuit points only by authorized electrician.</p>
	 Warning	<p>Warning! Explosion hazard caused by dust! Ground!</p>
	 Caution	<p>Caution! Risk of injuri! Ground!</p>
<p>Electrical connection and grounding</p>	<p>-16A Euro plug connector -Ground cabinet, cyclone and dust collector - min 10 mm² - Earth screw in stock, ground wire etc. no shipment</p>	
	 Caution	<p>Caution! Noise > 80dB(A) Wear ear protection!</p>
<p>Operation checkout without media</p>	<p>Close the doors. Switch-on elctricity (green push button). Control the following: -Is lighting on? -Is the fan motor starting?.Turns the motor in direction of the arrow? Otherwise reverse the polarity. -Is dedusting pulse for cartridge filter activ? (Interval. ca 40 s) -Take the nozzle in your hand and press the foot pedal.. Is the blast process starting? -Step on the foot pedal und open left resp. right door (2. person. Is the blast process stopping?Test cabinet with media, if no irregularities can</p>	

	be detected. Otherwise remedy errors. Therefor see section 6.
<i>Media loading</i>	<ul style="list-style-type: none"> - Exhauster off. - add media slowly into reclaiming hopper through the reclaiming door (blast pot). - Media capacity (initial fill) <ul style="list-style-type: none"> +Blast machine: 100l: 60l abrasive
<i>Operation checkout with media</i>	<ul style="list-style-type: none"> -Close the doors. - Adjust blast pressure. -Hold nozzle in direction grate. Step on the foot pedal → Blast process starts Check, if dust passes of (second person). <u>Critical zones:</u> <ul style="list-style-type: none"> -Doors -Suction hose connections -Connections between dust collector and dust container. <p>Note: Leak tightness can be remarked only during dedusting.</p>

6 Instruction handbook

6.1 Set up and operation, Shut down

<i>Turn on air supply</i>	
<i>Adjust blast pressure</i>	
<i>Switch on electricity</i>	Main switch and green push button
<i>Load parts to be blasted into the cabinet</i>	Close doors
<i>Blasting</i>	Hold blast gun/nozzle and step on the foot pedal
<i>Blow off media</i>	Clean parts with blow off gun
<i>Disconnect electricity</i>	<ul style="list-style-type: none"> -Main switch - Red push button - Dedusting process works still for ca. 5 min
<i>Disconnect air supply</i>	

6.2 Emergency stop

<i>Push emergency stop button</i>	Electrical supply is disconnected, dedusting too
<i>Depressurizing the installation</i>	see 6.4.1
Clarification of causation	see 8.

6.3 Shut down by longer interruption of work or moving the cabinet

<i>Remove media</i>	see 6.4.4.
<i>Disconnect electricity</i>	Authorized electrician
<i>Depressurize installation</i>	see 6.4.1.

6.4 Special procedures

6.4.1 Depressurizing

<p>Close external air supply</p>		<p>Depressurize moisture separator over drain screw</p>
----------------------------------	---	---

6.4.2 Adjust media / air mixture

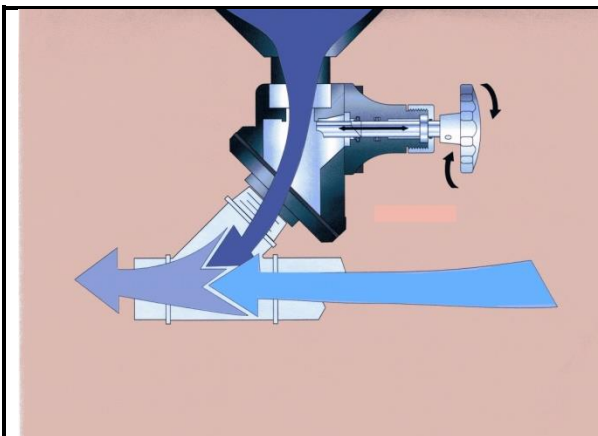
	<p><u>QK-Quantum abrasive metering valve</u></p> <p>The following steps must be followed in order to operate the manual Quantum metering valve:</p> <ol style="list-style-type: none">1. Start the blast operation2. Turn the metering knob <p>The manual metering valve adjusts abrasive flow by turning the metering knob.</p>
--	---

6.4.3 Negative pressure, view, media consumption and flow

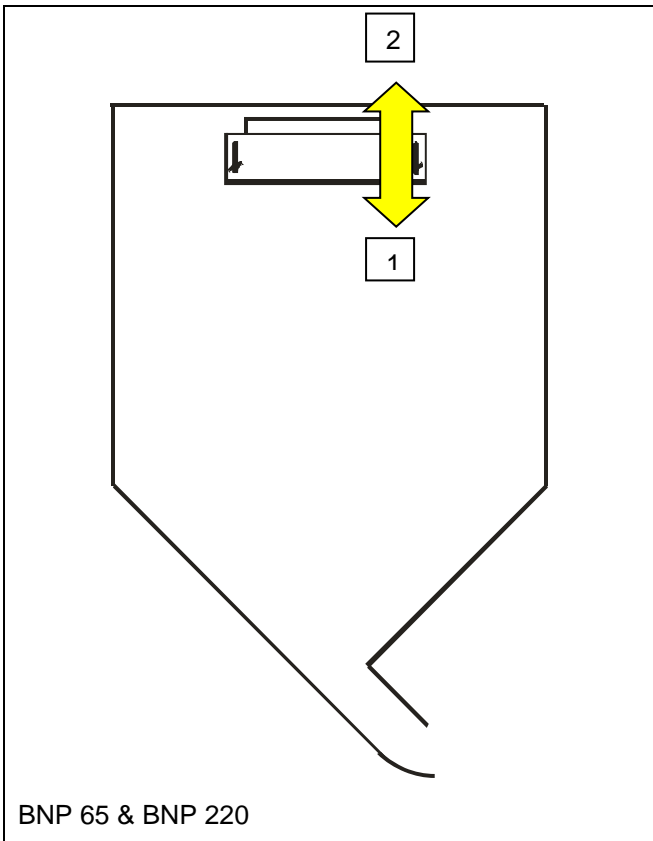
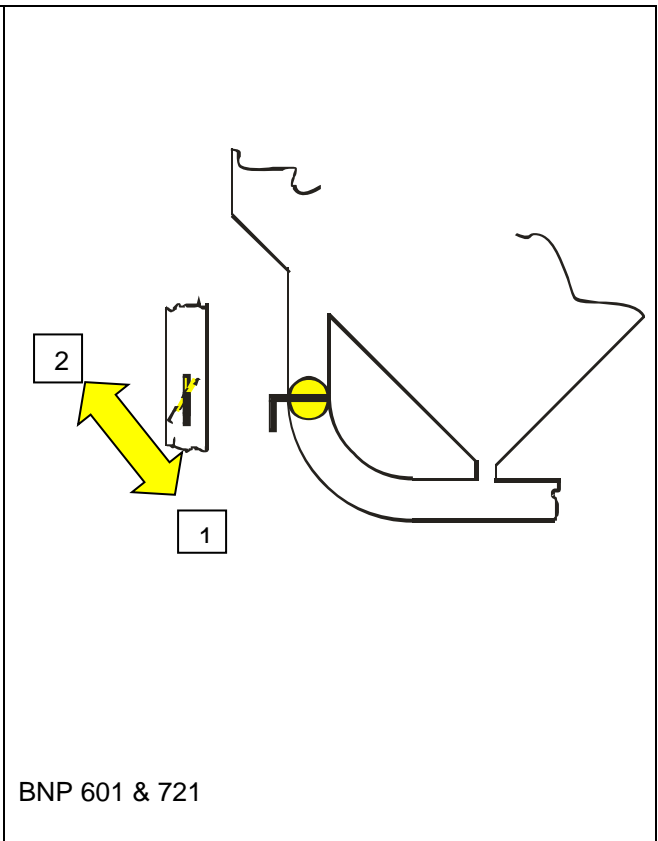
 <p>BNP 65 & BNP 220</p>	 <p>BNP 601 & 721</p>
---	---

Damper	Negative pressure	View	Media exhausting / Consumption	Media suction
1	lower	better	higher	better
2	higher	worse	lower	worse

6.4.4 Media unloading

Turn on exhauster	Green push button
Unloading the blast pot	<ul style="list-style-type: none"> - Close choke valve on the blast pot - Fully open media metering valve - Blasting pressure: low as possible - Unscrew nozzle and nozzle holder - Put a container such as a bucket on the cabinet grating - Hold hose into the container - Press foot pedal → direct media flow into the container
Cleaning cabinet	<ul style="list-style-type: none"> - Doors has to be closed - Exhauster is working - With blow off nozzle
Unloading the reclaimer / cyclone	- Open door and remove media into the blast pot
Unloading blast pot again	- Only residues

6.4.5 Pulsing (cleaning) dust collector cartridge / replace cartridge / disposal of residues

Replace cartridge	<ul style="list-style-type: none"> - Pulse filter cartridge two times <ul style="list-style-type: none"> -start cabinet again and turn off after more than 2min → + ca. 5 minutes dedusting pulse - Push emergency stop - Close air supply - Depressurize installation (see 6.4.1) - Unscrew filter cover - Pull a (≥ 120 l) plastic bag over the filter cartridge - Unscrew the nuts on the flange and pull out the filtercartridge with the plastic bag. - Screw the new filter cartridge and take care of the position of the seal kit. - Close dust collector cover
Empty dust container	<p>-release the dust container from the cover</p> <p>WARNING! If toxical residues, dispose dust as hazardous waste!</p>

6.4.6 Window replacement

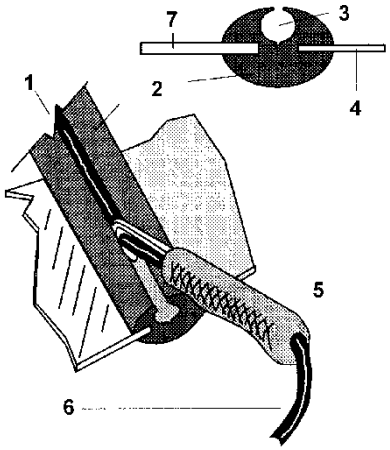
	No.:	Description
	1	Filler strip
	2	molding
	3	Place for filler strip
	4	Cabinet wall (fits into narrow slot)
	5	Window tool
	6	Filler strip
	7	window (fits into expanded slot)
<i>Pull filler strip from the window molding</i>		
<i>Remove window</i>		Push the window from the cabinet inside
<i>Install a new window molding</i>		Strip channel facing the front of the cabinetg
<i>Install window</i>		Push into the slot
<i>Thread filler strip</i>		With installation tool

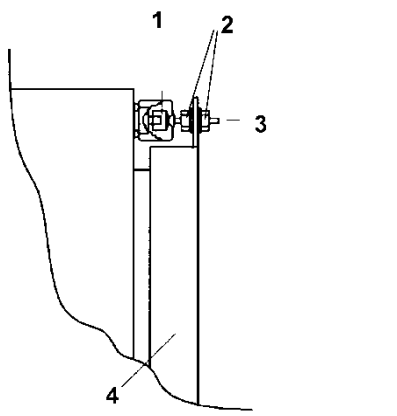

6.4.7 Adjust door safety interlock

	Nr:	Description
	1	Door safety interlock
	2	Nut for screw adjusting
	3	Actuating screw for safety interlock
	4	Cabinet door

7 Maintenance and cleanse

7.1 Preface

During operation the cabinets are exposed to wear. In order to ensure safe operation and high efficiency the blast machines must be maintained regularly.

	 Warning	Warning! Risk of injuri! Dicharge completely pressure during maintenance jobs. (see 6.4.1)
---	--	--

7.2 If required

	Check and if necessary. replace /cleanse
View window	-Cover lenses -If necessary window glass – see 6.4.6
Gloves	

7.3 After max. 8 h of blasting

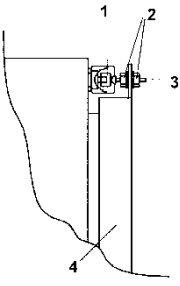
	Check and if necessary. replace /cleanse
Door interlock 	-Open doors - Press pin (1). It has to return from alone.
Empty dust container.	- Could be necessary already after one hour
Media recovery system (Reclaimer).	-Empty screen → Turn off exhauster. This may be necessary more often - Screen magnet .
Nozzle and nozzle holder	Check gasket for wear and replace if it's necessary

7.4 After max. 50 h of blasting

	Check and if necessary. replace /cleanse
(1) Blast gun and nozzle	Nozzle gasket.
(2) Moisture separator.	Clean filter and sight glass with soap and warm water
(3) Air hoses and blast hoses.	- Gaskets of couplings for wear -Blast hose by hand for soft spots
(4) Blast pot	- Pop up valve for wear by hand -Check wear of the pop-up valve by palpation with fingers

7.5 After max. 150 h of blasting

(1) Gasket on cabinet doors.	
(2) Filter cartridge.	- see 6.4.5



7.6 After other periods of time

	replace (even without wear) after maximal
Blast hoses	6 years
Remote control hoses	6 years
Air hoses – external air supply	6 years

O-rings	5 years
Pop up valve (blast pot)	5 years
Gaskets	5 years

8 Troubleshooting

Problem	Probable cause	Remedy
<i>(1) Poor visibility.</i>	Exhaust motor does not rotate.	
	Slide damper in false position	See 6.4.3
	Dirty filter cartridge.	Blow off filter cartridge. Replace (see 6.4.5).
	Exhaust motor rotates in the wrong direction.	Reverse polarity (only through licensed electrician).
	Blast media breaks down rapidly and creates dust	- Lower blast pressure - Other media.
	Blocked hose between blast cabinet and reclaimer / cyclone	Check and if necessary disassemble hose and remove dust and media. Blockage is not the real cause.
	Negative pressure.	Check the following components: - Reclaimer door open or leaky. - Test the connections of hose for leaks - Suction hoses for wear. - Dust leaking from dust container
<i>(2) Abnormally high media consumption.</i>	Cyclone door open or leaky.	Replace gasket.
	Too fine or too lightweight media.	Install and adjust supplementary a Vortex cylinder.
	Negative pressure too high	See 6.4.3
<i>(3) Poor cleaning rate.</i>	Not enough blast media in circuit.	Check and if necessary refill.
	Media metering valve is adjusted incorrect	A new adjustment is necessary (see 6.4.2).
	Reduced air-pressure	- Check air supply - If the static pressure decreases during blasting, the following components should be checked : + moisture separator + pressure regulator + nozzle
	Blocked blast hose or gun / nozzle.	- Push nozzle against an elastical object (for example rubber plate) and step on the foot pedal. - Disassembly hose or gun and cleanse. - Search after the cause of blockage: ⇒ Missing or overfilled screen in the reclaimer.

		<ul style="list-style-type: none"> ⇒ Incorrectly adjusted metering valve. ⇒ Too heavy blast media.
	Worn nozzle	-remove / change nozzle
	Moist blast media.	<ul style="list-style-type: none"> - Frequent bridging or blockage in the media metering valve can be caused by moist blast media. Following reasons could be possible: <ul style="list-style-type: none"> ⇒ Media was filled moistly → remove ⇒ Humidity from air supply → interconnect humidifier ⇒ Perspiration water caused by sharp drop in room temperature → Make sure, that there is not too much temperature fluctuation.
(4) Dust comes out the blower	Dust filter gasket defective.	-Replace gasket -see 6.4.5
	Defective cartridge.	- Replace cartridge -see 6.4.5
(5) Static shocks		<ul style="list-style-type: none"> - improve grounding of the cabinet. - in exceptional cases use supplementary ground wire between blast gun and cabinet wall
(6) No air and no media comes out the nozzle	Door interlocks are not actuated	Adjust pin resp. door fixing bzw. see 6.4.7
	Wrong connection of pneumatic hoses on foot pedal → permanent air blow off	<ul style="list-style-type: none"> - Only when foot pedal was new installed - Connect properly
	Polluted (blocked) moisture separator.	Cleanse moisture separator
	Hose of control lines leaky	<ul style="list-style-type: none"> - Need of second person - First person „is blasting“ - Second person checks leakages on controles lines
(7) Air only (no media) comes out the nozzle	No blast media in the blast circuit	-Refill
	Moist media	<ul style="list-style-type: none"> -Remove moist media. -Remove cause for humid air supply.
		<p>Caution! Risk of injuri!</p> <p>Dicharge completely pressure during maintenance jobs.</p>
(8) No interruption of blast process when foo pedal is released	Foot pedal valve blocked.	<ul style="list-style-type: none"> - depressurize the installation (see 6.4.1) - replace foot pedal valve
(9) Irregular flow or too much blast media comes out the nozzle	Incorrect adjusted media flow.	Adjust new (see 6.4.2).

(10) Media remains in the suction hose	Incorrect adjusted negative pressure	See 6.4.3
	Media too heavy	Use other media

9 Admitted modifications for users

Only with the approval of the producer! Otherwise the installation will lose guarantee and CE-certification.

10 Replacement parts

10.1 Replacement parts BNP 65, BNP 75, BNP 85 and BNP 220

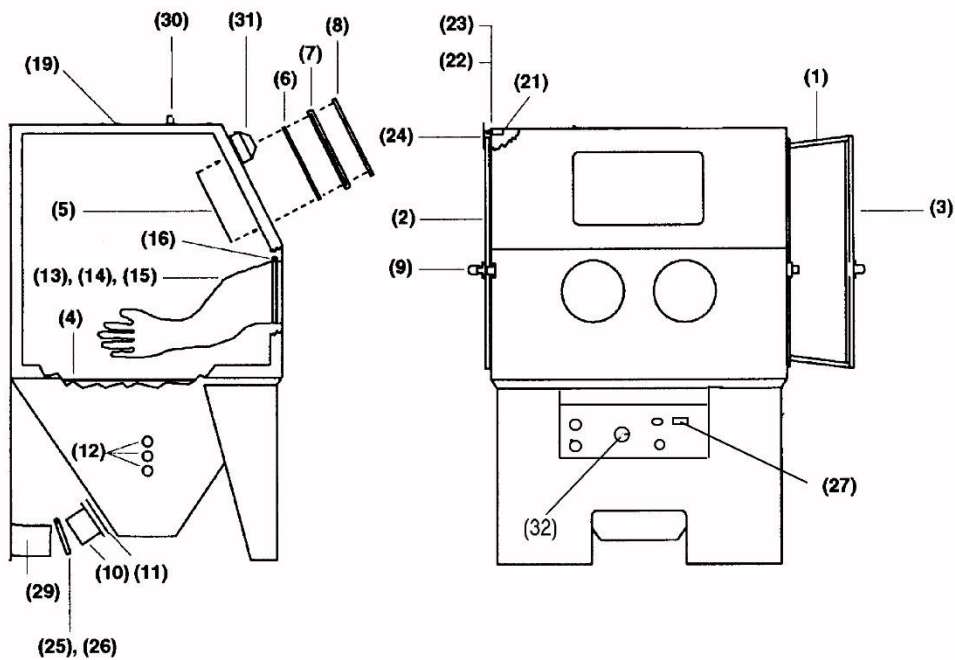

Pos.	Description	BNP 65 / BNP 75	BNP 85 / BNP 220
(1)	Door gasket per m	12434Z	12434Z
(2)	Left door complete	100326	100328
(3)	Right door complete	100327	100329
(4)	Gate	11811Z	11810Z
(5)	Mylar lens cabinet (5 pcs) small	06190Z	06190Z
-	Change frame mylar (5 pcs)- small	100960	100960
-	Glass change frame-small	100991	100991
-	Chain /m (necessary 0,5m)	24273Z	24273Z
-	Door gasket (2m)	12434Z	12434Z
-	Star handle IG M8	100551	100551
(6)	Window glass 0583-0001 (security glass)	12212Z	12212Z
(7)	Gasket for window glass small (1,65m)	12435Z	12435Z
(8)	Filler strip for window glass small (1,65m)	12436Z	12436Z

	Tool for window mounting	12176Z	12176Z
(9)	Door opener special for cabinet	99585Z	99585Z
(10)	Adapter Ø 100 mm / 4"	12376Z	-
	Adapter Ø 125 mm / 5"	-	12377Z
(11)	Gasket Ø 100 mm / 4" for adapter	11776Z	-
	Gasket Ø 125 mm / 5" for adapter	-	11777Z
(12)	Grommet for air hose 0236-0025	11798Z	11798Z
	Rubber sleeve for 19x7	11799Z	11799Z
(13)	Rubber gloves pair	99159Z	99159Z
	Cotton gloves cabinet (pair)	100585	100585
(14)	Rubber glove, left	12710Z	12710Z
(15)	Rubber glove, right	12711Z	12711Z
(16)	Clamp (for gloves)	11576Z	11576Z
(19)	Grommet 0236-0001 (for blast hose 6 mm)	12762Z	12762Z
(21)	Bushing safety door valve	15042Z	15042Z
(23)	Pneumatic valve safety door	12202Z	12202Z
(25)	Clamp f. Ø 100 mm / 4" (wire)	90241Z	
(26)	Clamp f. Ø 125 mm / 5" (wire)		90260Z
(27)	Hour counter	100579	100579
(29)	Suction hose PU Ø 100 mm / 4" per m	12447Z	-
	Suction hose PU Ø 125 mm / 5" per m	-	12449Z
(31)	Lamp less regulator (2x15W)	19574Z	19574Z
(-)	Lamp 0312-0004	11872Z	11872Z
		100742	100742
(-)	Lamp holder	11843Z	11843Z
	Handhole rubber set for cabinet 238mm (OD)	99912Z	99912Z
	Handhole ring for cabinet	99913Z	99913Z
	Y-150x100x100 – for MBX 1500	11379Z *only BNP 75	11379Z * only BNP 85

10.2 Replacement parts BNP 601 and 721

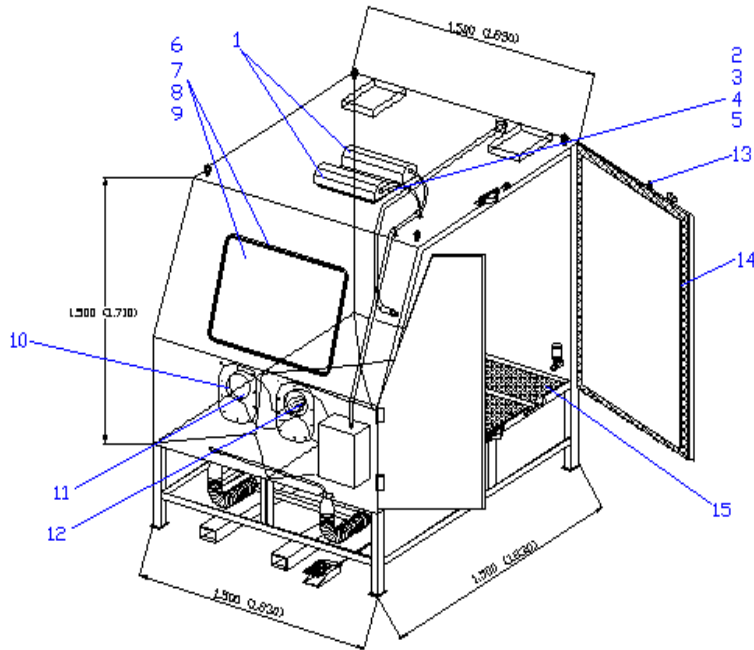

Pos.	Description	BNP 601	BNP 721
(1)	Lamp complete LED (36W)	100695	100695
(2)	Mylar lens (small window glass)-5 pcs.	06190Z	06190Z
(6)	Mylar lens (large window glass) – 5 pcs.	100661	100661
(3)	Filler strip for: - Window glass-small (1,65 m)	12436Z	12436Z
(7)	- Window glass-large (2,70 m)	100963	100963
(4)	Gasket window glass for: - window glass-small (1,65 m)	12435Z	12435Z
(8)	- window glass-large (2,70m)	100962	100962
(5)	Window glass 0583-0001 – small 497 x 317 mm (security glass)	12212Z	12212Z
(9)	Window glass (20" x 30") 0583-0002- large	12213Z	12213Z
	Change frame complete	100959	100959
	Gasket 3 m	12434Z	12434Z
	Star handle	100551	100551
	Glass change frame small	100991	100991
	Window glass for Change frame large 535 x 800 x 3mm	100992	100992
(10)	Clamp for glove	11576Z	11576Z
	Rubber gloves-pair	99159Z	99159Z
(11)	Rubber glove, left	12710Z	12710Z
(12)	Rubber glove, right	12711Z	12711Z
(13)	Door opener special for cabinet	11879Z	11879Z

(14)	Door gasket	90233Z	90233Z
(15)	Grating (4 pcs. / cabinet)	100367	100394
	Control box - complete	100402	100402

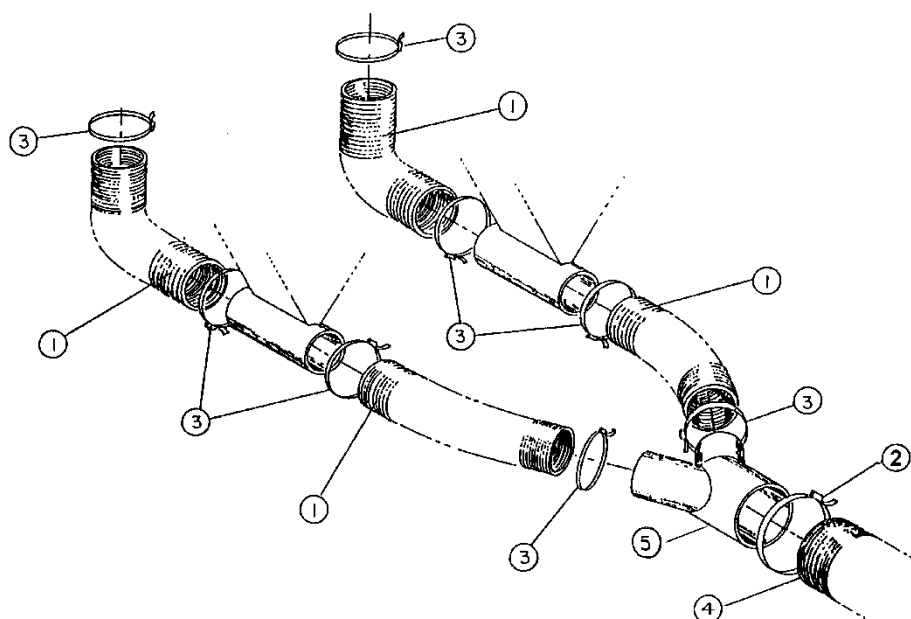

Picture12: Replacement parts BNP-601 and 721

Pos.	Description	601	721
(1)	Suction hose Ø 100 mm / 4" PUR	12447Z	12447Z
(2)	Clamp Ø 150 mm / 6" wire	90261Z	90261Z
(3)	Clamp Ø 100 mm / 4" wire	90241Z	90241Z
(4)	Suction hose Ø 150 mm / 6"	12452Z	12452Z
(5)	Y-piece 180-100-100	19998Z	19998Z
	Y-piece 150-100-100	12379Z	12379Z
	Y-piece 150-180-180	14279Z	14279Z

10.3 Pneumatic circuit- manual abrasive metering valve

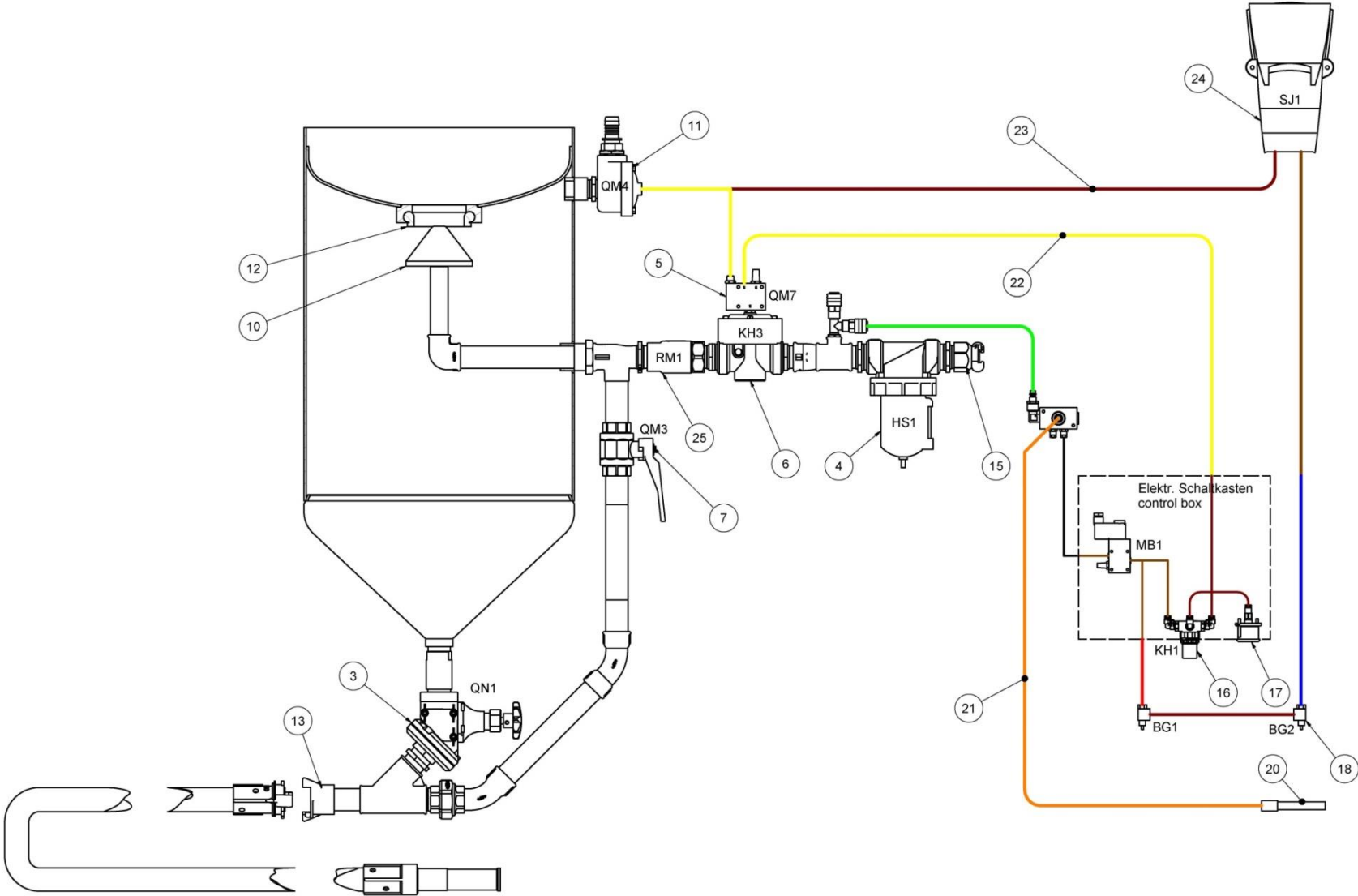

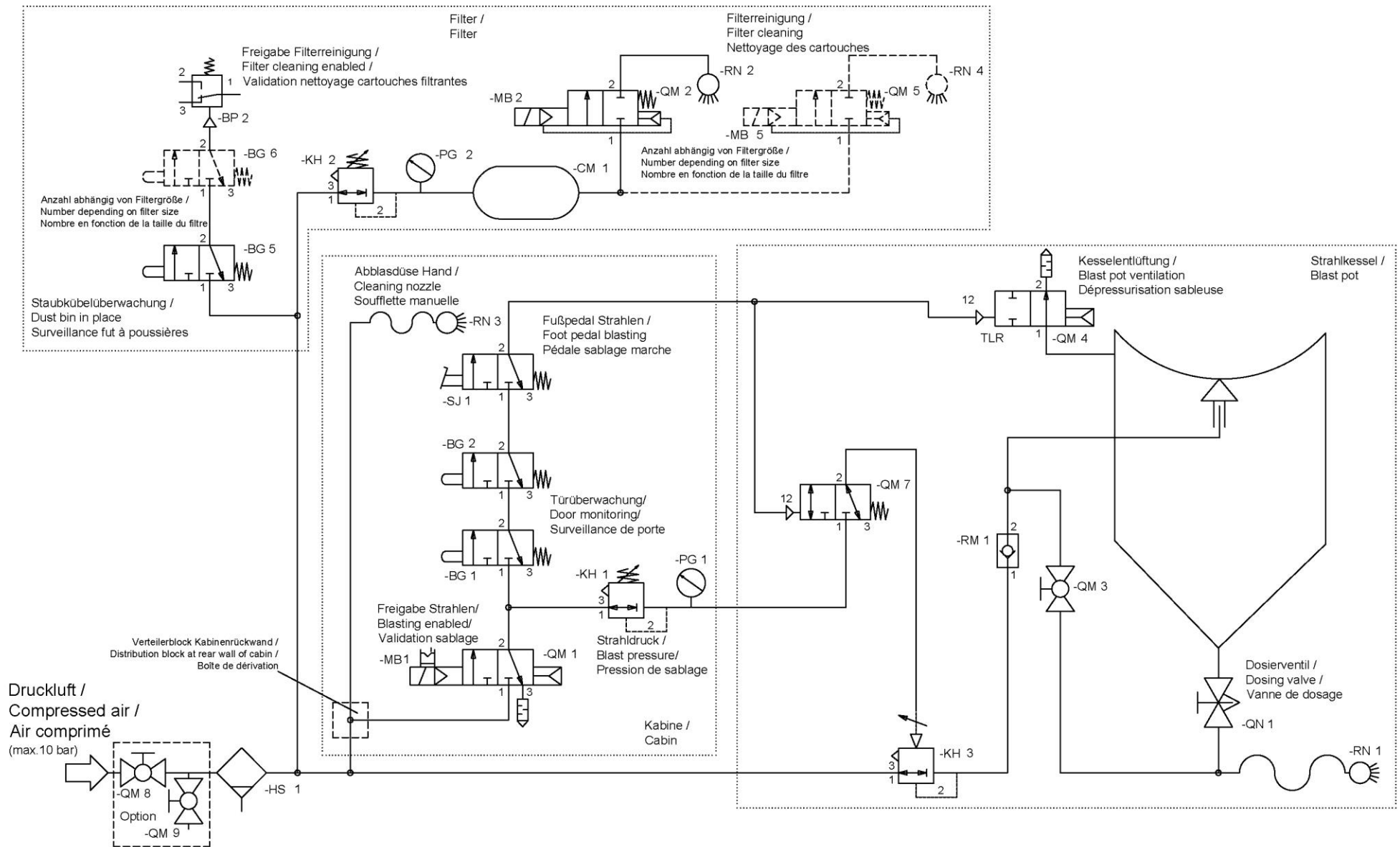

Pos.	Description	For blast pot with pipung 1 ¼"
HS1	Water separator	90545D
KH1, KH2 PG1 PG2	Pressure regulator ¼" (Pilot regulator) Gauge (front mounting) Gauge (individually)	100061 (incl. gauge) 11831Z 100399
KH3	Pressure regulator	10711Z
BG1 / BG2 BG5 / BG6	Pneumatic valve dustbin monitoring	12202Z
BP2	PE-converter dustbin monitoring	100835
RN3	Blow off nozzle 0348-0022 cabinet	13116Z
RN2, RN4	Blow-off nozzle filter	See additional owner's manual „MBX dust collector“
QM1	3/2 way valve 1/8"	100741
RN1	Nozze, nozzle holder	see 10.5
QN1	Media metering valve	22780D
QM2, QM5	Diaphragm valve	See additional owner's manual „MBX dust collector“
QM7	3/2 way valve, pneum.	99406D
QM4	Auslaßventil TLR Strahlkessel	03371I
QM3, QM8	Ball valve 1 ¼"	02397D
RM1	Non return valve with rubber ball	99633D
QM9	Ball valve ½"	01241D
SJ1	Foot pedal	06266Z
CM1	Compressed air buffer	24289Z (See additional owner's manual „MBX dust collector“)
MB1, MB2, MB5	Solenoid coil 230V AC for pneumatic valve	99697Z 100039 (See additional owner's manual „MBX dust collector“)
without	Air hose 1/8" pro Meter	12475Z
without	Air hose (yellow)	99279D

10.4 Blast machine

See additional owner's manual

10.5 Nozzles, Blast hose, Couplings, etc

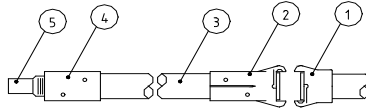

Pos.	Description	For blast machine with 1 ¼" piping
(1)	CFT –Iron cast coupling 1 ¼" (pot)	91011D
(2)	CQP ¾" Plastic coupling for 19x7	94350D
(3)	Blast hose 19 x 7 pro m	04301D
(4)	NHP-3/4" nozzle holder f. blast hose 19x7	99204D
(5)	Nozzles with coarse thread 50 mm	
	CTJG-3 Clemlast TC 4,8mm	05288D
	CTJG-4 Clemlast TC 6,5mm	05289D
	CTJG-5 Clemlast TC 8mm Standard	05290D
(-)	Nozzle holder	100559
(-)	Clamp ZERO 12mm	99868Z
	Nozzle holder NHP-0	100567
	Nozzle holder NHP-1	100568

10.6 Foot pedal



Pos.	Description	Part no.
(-)	3-way foot valve complete	06266Z
(-)	Silencer ¼"	90941D
(-)	Pipe plug ¼"	01950D

10.7 Cyclon pression

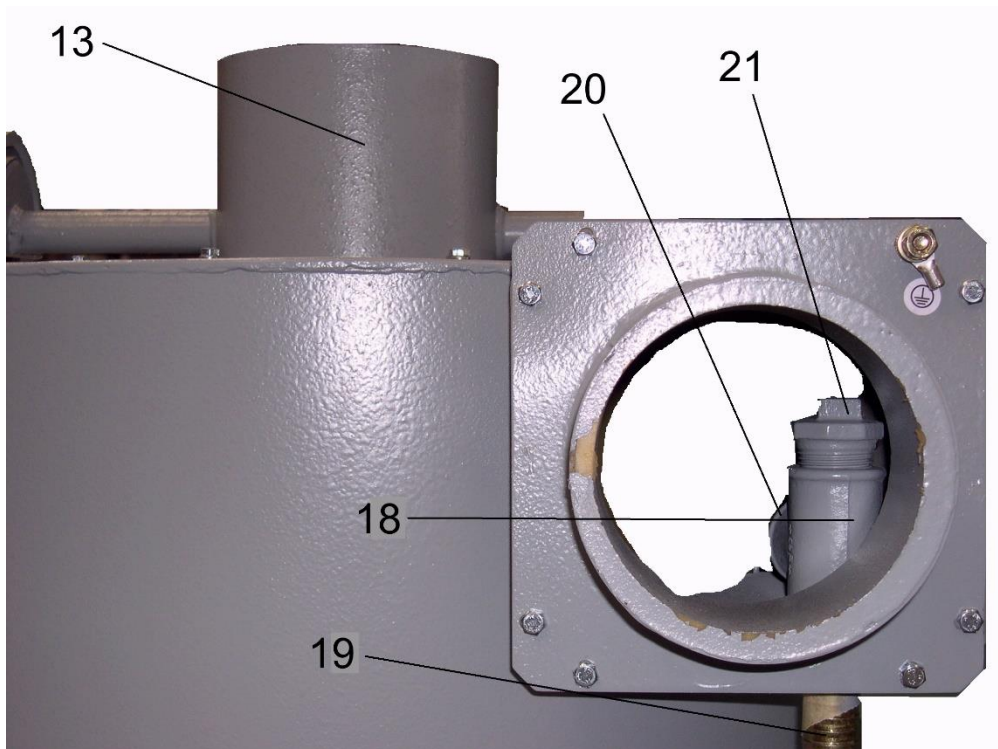
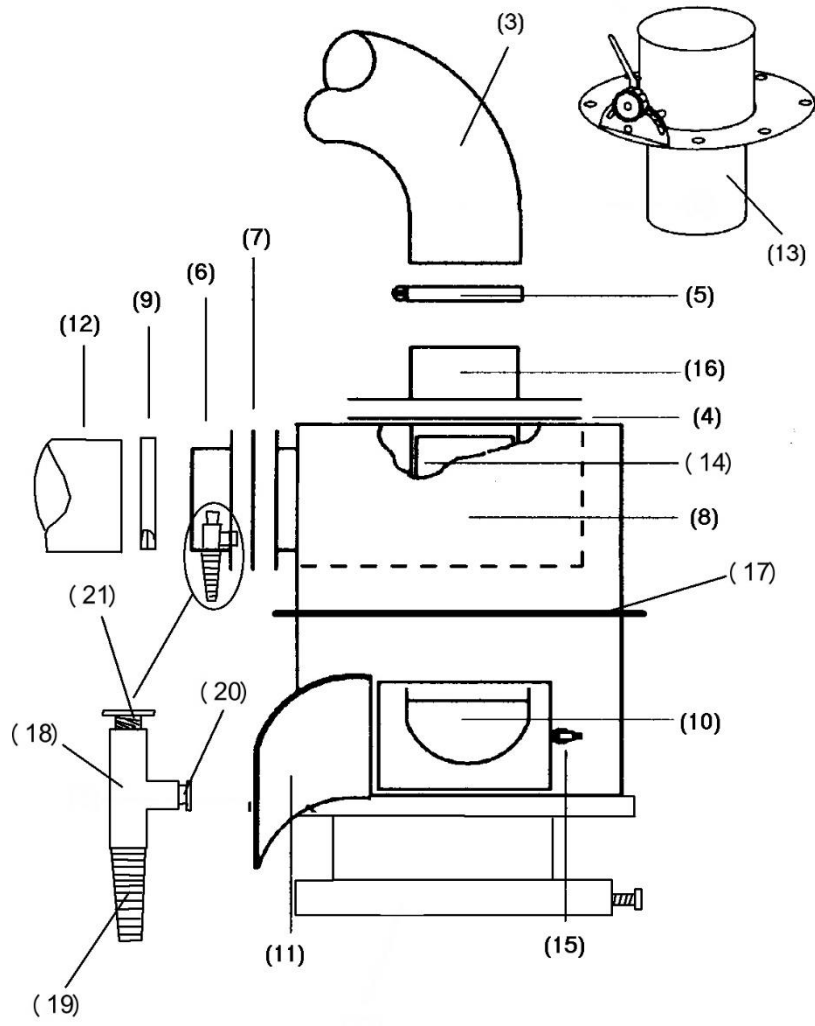

Pos.	Part no.	Type	Description
(-)	99959Z	16,8 m ³ /min.	Cyclon, pression, with flange for 1628, 1440 complete
	99533Z	25,4 m ³ /min.	Cyclon, pression, with flange for 2040 complete
	99750Z	25,4 m ³ /min.	Cyclon, pression, with flange for 2452 complete
	99532Z	34 m ³ /min.	Cycklon, pression, with flange for 2452 complete
(3)	12447Z	16,8 m ³ /min.	Suction hose 100mm / 4" per m
	12449Z	25,4 m ³ /min.	Suction hose 125mm / 5" per m
	12452Z	25,4 m ³ /min.	Suction hose 150mm / 6" per m
	12448Z	34 m ³ /min.	Suction hose 180mm / 7" per m
	12470Z	50 m ³ /min	Suction hose 200mm / 8" per m
(4)	99751Z		Gasket per m
(5)	90241Z		Clamp Ø 100mm / 4"
	902610Z		Clamp Ø 225mm / 5"
	90261Z		Clamp Ø 150mm / 6"
	90265Z		Clamp Ø 180mm / 7"
	90277Z		Clamp Ø 200mm / 8"
	90279Z		Clamp Ø 225mm / 9"
(6)	12361Z	16,8 m ³ /min.	Adaptor 125 mm Ø / 5"
	12363Z	25,4 m ³ /min.	Adaptor 150 mm Ø / 6"
	17277Z	34 m ³ /min.	Adaptor 180 mm Ø / 7"
(7)	11746Z		Gasket for adaptor 100 mm Ø / 4"
	11779Z		Gasket for adaptor 125 mm Ø / 5"
	11759Z		Gasket for adaptor 150 mm Ø / 6"
(8)	11985Z	16,8 m ³ /min.	Rubber wear plate
	11982Z	25,4 m ³ /min.	Rubber wear plate
	11980Z	34 m ³ /min.	Rubber wear plate
(9)	90260Z		Clamp 125 mm Ø / 5"
	90261Z		Clamp 150 mm Ø / 6"
	90265Z		Clamp 180 mm Ø / 7"
(10)	13131Z		Screen fine 2-3 mm (old design)
	17028Z		Screen coarse 5mm (old design)
	21265Z		Screen fine (new design) 2-3 mm
	21280Z		Set for screen fixing
	21275Z		Screen coarse (new design) 5 mm
(11)	14271Z		Door
	11745Z		Door gasket cyclon
(12)	12449Z	16,8 m ³ /min.	Suction hose 125 mm Ø / 5" per m
	12452Z	25,4 m ³ /min.	Suction hose 150 mm Ø / 6" per m
	12448Z	34 m ³ /min.	Suction hose 180 mm Ø / 7" per m

(13)	19080Z	16,8 m ³ /min.	Vortex cylinder for cyclon Ø 150 mm
	19084Z	25,4 m ³ /min.	Vortex cylinder for cyclon Ø 180 mm
	19087Z	34 m ³ /min.	Vortex cylinder for cyclon Ø 225 mm
(14)	ohne		Vortex pipe
(15)	12263Z		Door latch
(16)	99970Z	16,8 m ³ /min.	Pipe for cyclon Ø 150 mm (outlet adaptor)
	16832Z	25,4 m ³ /min.	Pipe for cyclon Ø 180 mm (outlet adaptor)
	99610Z	34 m ³ /min.	Pipe for cyclon Ø 200 mm (outlet adaptor)
(17)	100166		Flange ring cyclon devided (Possibility to attach a connection flange)
(18)*	94201D		T-piece 1" No. 130
(19)*	94301D	1"	Hose fitting 1"x25
(20)*	12011D		Plug 1" NPT
(21)*	27349Z	1"	Plug 1" with holes
(-)	15580Z		Magnet for screen
(-)	99958Z	1628	Silo with door
	99166Z	2040	Silo 300 mm with door
	99167Z	2452	Silo with door

10.8 Dust collector and blower

See additional owner's manual.

10.9 Control box

Pos.	Description	Part no.:
without	Emergency STOP button	100742
without	Solenoid valve 1/8"	100741
without	Module- Pulsar – see table 8.10 for different voltage and power	
without	Push button (green)	100736
without	Push button (red)	100737
without	Gauge	11831Z
without	Pressure regulator	100061
without	Fuses F1 to F5 per piece – see separate table	
without	Earth screw	100732

10.10 Options - different voltage and power

	1,5 kW	2,2kW	4,0 kW
1 x 230 V	X	X	X
3 x 230 V	X	X	X
3 x 400 V	X	X	X
Standard			

10.11 Grounding

Pos.	Description	Part no.
(-)	Earth screw M8 complete with nut, lug and earth washer	100732
(-)	Ground wire 10 mm ² per m	100769

10.12 Options, Accessories

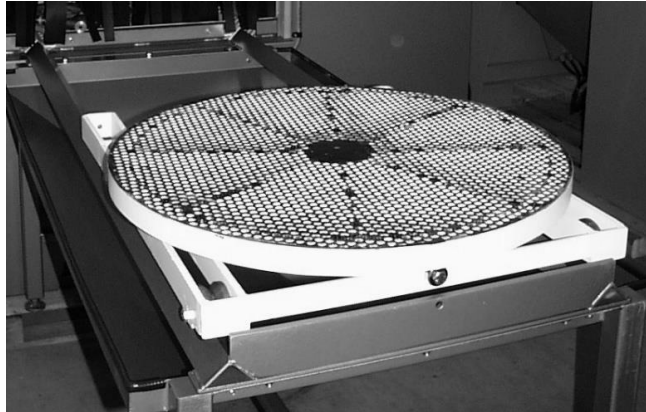

Figure 9: Track assembly: truck, hopper, work car with turntable

Pos.	Description	BNP 65 / 75	BNP 220 / 85	BNP 601	BNP 721	Re-fitting requirements
(-)	Turntable, truck, hopper + work car	13530Z	12835Z	12524Z	12523Z	Opening for rails
(-)	Turntable Ø 760 mm only	90881Z	90881Z			
(-)	Turntable Ø 1200 mm only			21400Z	21400Z	
	Wheel for car complete	24337Z	24337Z	27355Z	27355Z	
	Wheel for work car without bearing	90987Z	90987Z	27356Z	27356Z	
	Bearing	100479	100479	30540Z	30540Z	
	Screw for bearing cover / Stück	100480	100480	100480	100480	
	Wheel axle	100478	100478	30541Z	30541Z	
(-)	Stationary turntable Ø 760 mm complete	99840Z	99840Z			none
(-)	Gate 300 x 300 mm (per pcs.)	100282	100282	100282	100282	Openings in door
(-)	Gate 400 x 400 mm (per pcs.)	*1)	100283	100283	100283	Openings in door
(-)	Port 300 x 300 mm including mounting	90681Z	90681Z	90681Z	90681Z	Openings in door
(-)	Port 400 x 400 mm including mounting	*1)	100302	100302	100302	Openings in door
(-)	Tumble 4,5 l complete with E-motor 230V (door mounting possible))	100549	100549	100549	100549	Openings in door Setting electrical connections

	Tumble 30 l complete with E-Motor 230V (door mounting possible)	Not recommended	100548	100548	100548	Openings in door Setting electrical connections
(-)	Tool for window installation	12176Z	12176Z	12176Z	12176Z	

*1) not possible

10.12.1 Further options

	Re-fittings possibles by customer
Reinforcements for loadings till 5000 N	conditional
Reinforcements for loadings till 20000 N	no
Oscillator horizontal , vertical)	no
Rubber coating	yes
PU coating	no
Grounding the nozzle	yes

11 Disposal

Unless a return or disposal agreement has been made, recycle the dismantled components:

- Scrap metals.
- Send plastic elements for recycling.
- Dispose of remaining components sorted according to material properties.

	<p>ATTENTION!</p> <p>Environmental damage through incorrect disposal! Electronic scrap, electronic components, lubricants and other auxiliary materials are subject to hazardous waste treatment and may only be disposed of by approved specialist companies!</p>
---	---

The local authority or special waste disposal companies provide information on environmentally friendly disposal.